

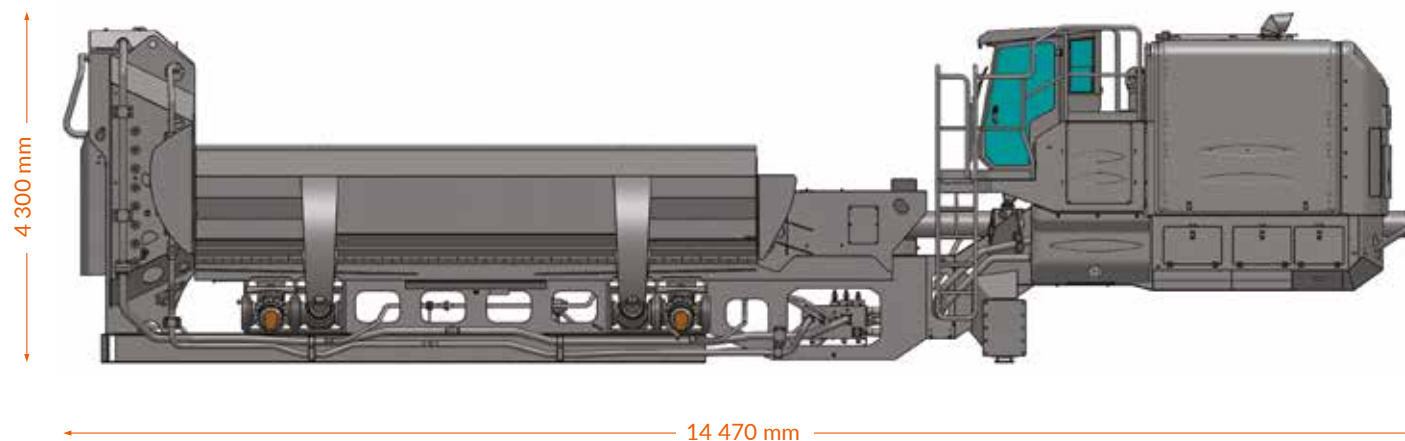

.Konkeror 600

BOX 866 TS

.600



SPECIFICATIONS

Cutting force	600 T
Hold down force	120 T
Box closing force	2 x 240 T
Pusher ram force	180 T
Cutting width	800 mm
Box length	6000 mm

Box section opened	2450 mm
Box section closed	800 x 600 mm
Hydraulic oil tank capacity	2000 l
Diesel tank capacity	1200 l
Total weight	49 T
Diesel power unit	400 hp

These features are not contractual. LEFORT reserves the right to modify its specifications without any prior notice.

.Contact

LEFORT S.A.
Rue Tahon, 1 a
6041 - Gosselies
Belgium

T. + 32 71 35.16.09
@. info@lefort.com

.Konkeror 600

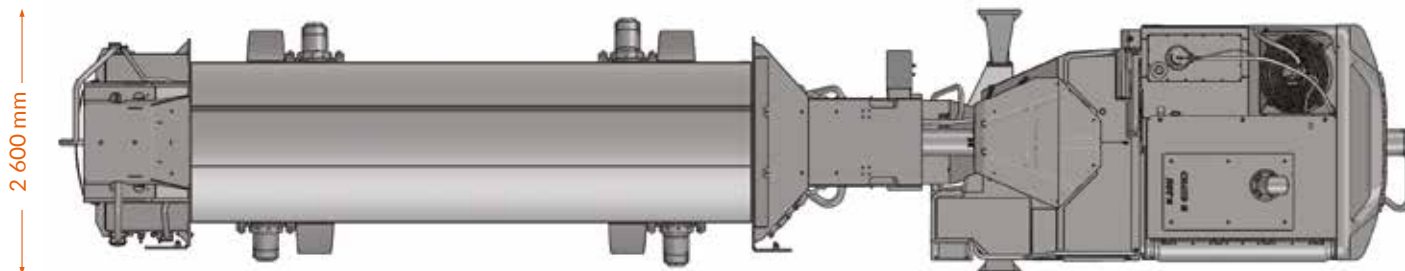

.Contact

LEFORT S.A.
Rue Tahon, 1 a
6041 - Gosselies
Belgium

T. + 32 71 35.16.09
@. info@lefort.com